

RT25

(A463)

RT25 (A463)

Location of Unit	3
1. Paper Conveyor Unit (A463)	4
2. Paper Feed Unit (A463)	6
3. Exterior 1 (A463)	8
4. Exterior 2 (A463)	10
5. Harness Layout (A463)	12
6. Option Tray Harness (A463)	14
7. Drawer and Join Harnesses (A463)	16
8. Decal and Document (A463)	18
Parts Index	22

LOCATION OF UNIT

April 30, '89

1. PAPER CONVEYOR UNIT

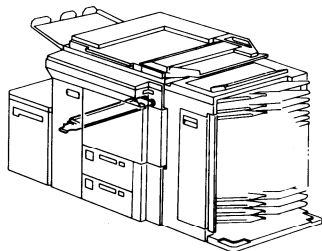

See page 4

2. PAPER FEED UNIT

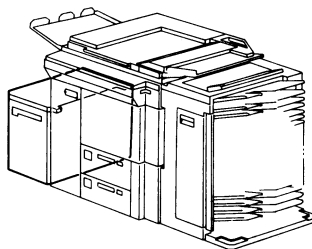

See page 6

3. EXTERIOR 1

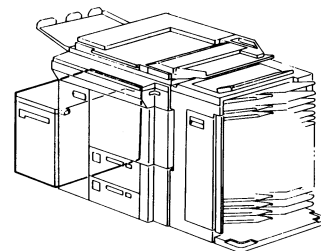

See page 8

4. EXTERIOR 2

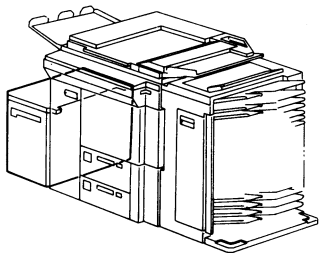

See page 10

1. PAPER CONVEYOR UNIT (A463)

April 30, '89

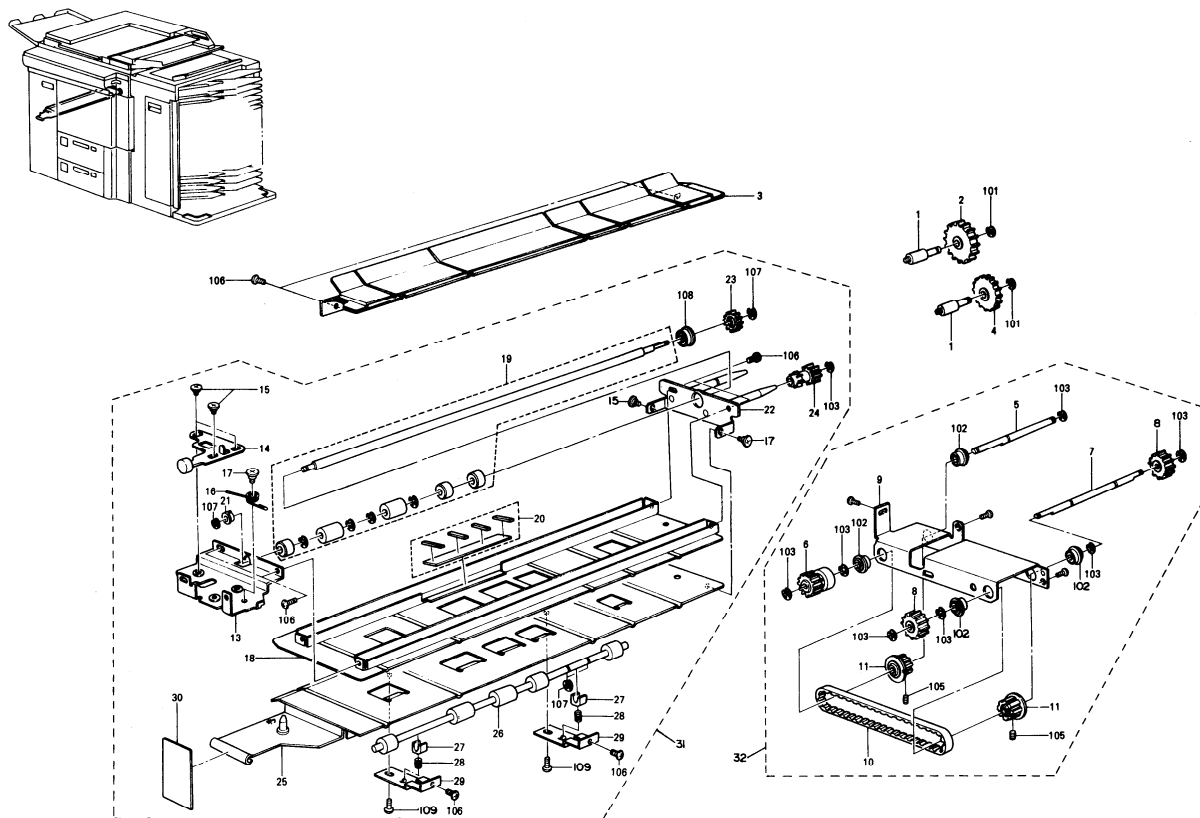

1. PAPER CONVEYOR UNIT (A463)

April 30, '89

Index No.	Part No.	Description	Q'ty Per Assembly
1	5938 2618	Stud - Lateral Transport Drive	2
2	5938 2622	Gear - 36T	1
3	5938 2625	Paper Guide Plate	1
4	5938 2620	Gear - 31T	1
5	5938 2611	Left Shaft - Lateral Transport Drive	1
6	5938 2613	Gear - 25T	1
7	5938 2605	Right Shaft - Lateral Transport Drive	1
8	5938 2607	Gear - 25T	2
9	5938 2601	Bracket - Lateral Transport Drive	1
10	5938 2615	Timing Belt - 130XL	1
11	5938 2609	Pulley - 14T	2
13	5938 2553	Front Side - Lateral Transport	1
14	A029 4677	Release Lever	1
15	5201 1796	Stepped Screw - M4	4
16	5219 6069	Release Spring - Duplex Unit	1
17	5403 6246	Stepped Screw - Cleaning	2
18	5938 2565	Guide Plate - Lateral Transport	1
19	5938 2563	Upper Transport Roller	1
20	5938 2569	Scraper - Paper Dust Cleaner	1
21	5875 2067	Bushing - 6x10x6mm	1
22	5938 2560	Rear Side Plate - Lateral Transport	1
23	5446 3158	Gear - 16T	1
24	5938 2576	Coupled Gear - 16T/18T	1
25	5938 2580	Lower Guide Plate	1
26	5938 2595	Lower Transport Roller	1
27	5938 2597	Pressure Bushing - 8mm	2
28	5938 2598	Spring - Lower Transport Roller	2
29	5938 2599	Pressure Plate - Transport Roller	2
30	A029 4982	Dcal - Release Plate	1
31	A463 2560	Paper Conveyer Unit	1
32	5938 2600	Paper Conveyer Drive Unit	1

Index No.	Part No.	Description	Q'ty Per Assembly
101	0720 0060E	Retaining Ring - M6	
102	0742 3808	Ball Bearing - 8x16mm	
103	0720 0060E	Retaining Ring - M6	
105	0575 0050E	Hexagon Headless Set Screw - M5x5	
106	0314 0060W	Phillips Pan Head Screw - M4x6	
107	0720 0040E	Retaining Ring - M4	
108	0742 3906	Ball Bearing - M8	
109	0951 4006W	Phillips Screw With Flat Washer - M4x6	

2. PAPER FEED UNIT (A463)

April 30, '89

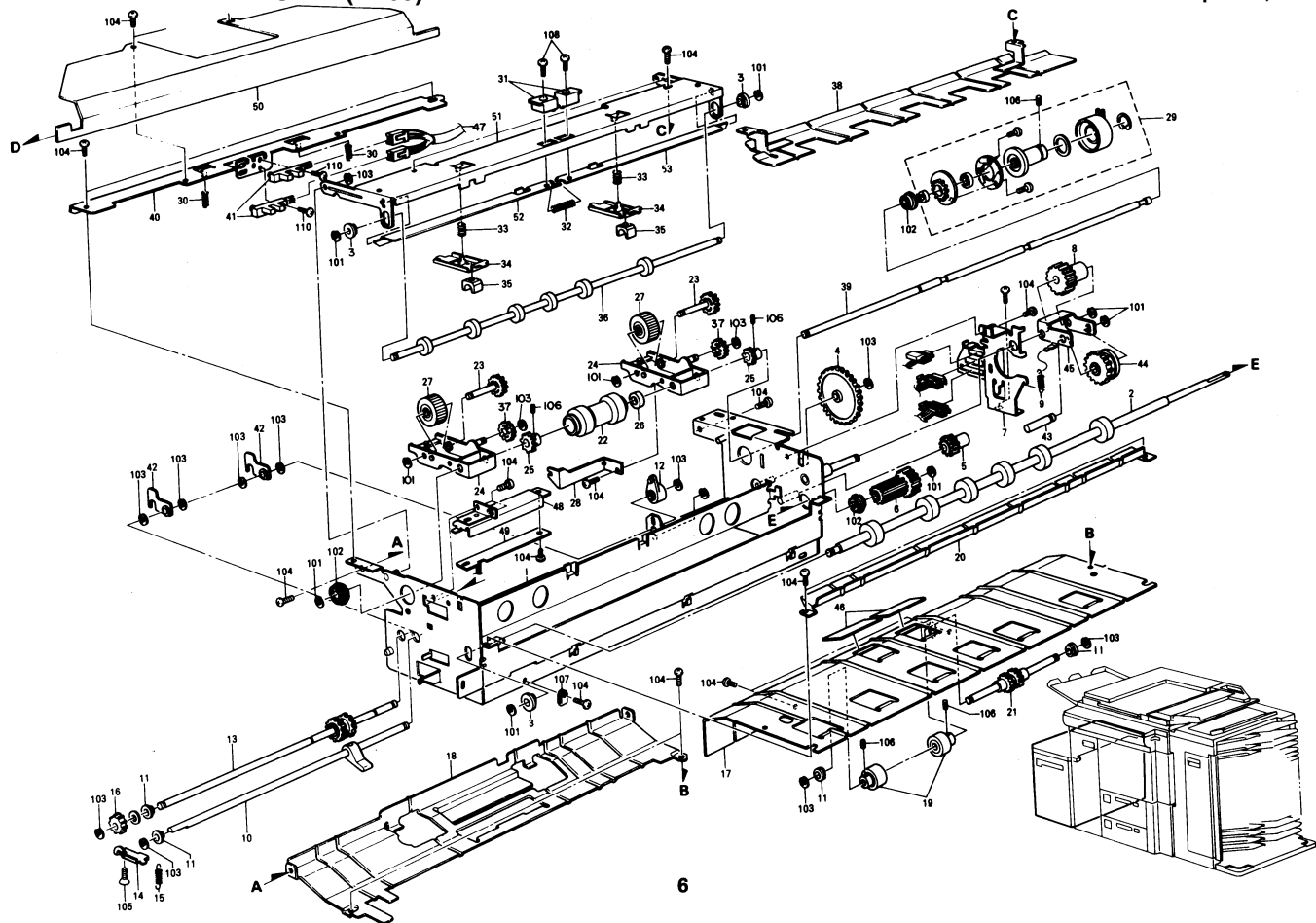

2. PAPER FEED UNIT (A463)

April 30, '89

Index No.	Part No.	Description	Q'ty Per Assembly
1	5938 2843	Paper Feed Frame	1
2	5938 2856	Transport Drive Roller	1
3	5304 1639	Bushing - 8mm	3
4	5446 2862	Gear - 36T	1
5	5938 2883	Gear - 24T	1
6	5938 2882	Coupled Gear - 16T/24T	1
7	5938 2884	Drive Gear Bracket	1
8	5938 2880	Gear - 20T	1
9	5938 2885	Spring - Gear Shaft Holder	1
10	5938 2857	Pressure Shaft - Separation Roller	1
11	5053 0447	Bushing - 6x10x6mm	4
12	5938 2869	Separation Roller Stopper	1
13	5938 2859	Reverse Gear Shaft	1
14	5938 2870	Pressure Lever - Separation Roller	1
15	5938 2905	Spring - Separation Poller	1
16	5938 2868	Gear - 18T	1
17	5938 2862	Lower Guide Plate	1
18	5938 2871	Upper Guide - Separation Roller	1
19	5219 2940	Bottom Separation Roller	2
20	5938 2873	Upper Transport Guide	1
21	5446 2926	Shaft - Lower Separation Roller	1
22	5219 2931	Upper Separation Roller	1
23	5446 2891	Paper Feed Gear - 22T	2
24	5219 2898	Holder - Paper Feed Roller	2
25	5446 2895	Gear - 20T	2
26	5446 2901	Collar - 8mm	1
27	5429 7069	Pick-up Roller	2
28	5938 2867	Actuator - Upper Volume Sensor	1
29	5446 5445	Magnetic Clutch - 5KGF.CM 20T	1
30	5938 2907	Spring - Paper Feed Pressure	2
31	A463 2901	Open Section Knob	2
32	5938 2892	Spring - Lock Lever	1
33	5446 2799	Spring - Transport Roller	2
34	5938 2893	Pressure Plate	2
35	5938 2597	Pressure Bushing - 8mm	2

Index No.	Part No.	Description	Q'ty Per Assembly
36	5938 2894	Transport Driven Roller	1
37	5866 1677	Belt Roller Gear - 17T	2
38	5938 2895	Guide Plate - Open Section	1
39	5938 2866	Shaft - Upper Separation Roller	1
40	5938 2872	Bracket - Upper Limit Sensor	1
41	5219 5600	Photo Coupler	2
42	5446 2874	Positioning Arm	2
43	5938 2877	Gear Shaft - 30T	1
44	5938 2878	Gear - 30T	1
45	5938 2876	Gear Shaft Holder	1
46	5446 2924	Mylar - Separation Guide	2
47	5938 5009	Join Harness	1
48	5938 2902	Bracket Paper Feed Sensor	1
49	5938 5011	Papeer Feed Sensor	1
50	5938 2899	Separation Roller Cover	1
51	5938 2888	Open Section Bracket	1
52	5938 2889	Front Lock Lever	1
53	5938 2890	Rear Lock Lever	1
101	0720 0060E	Retaining Ring - M6	
102	0742 3808	Ball Bearing - 8x16mm	
103	0720 0040E	Retaining Ring - M4	
104	0314 0060W	Philips Pan Head Screw - M4x6	
105	0313 0050W	Philips Pan Head Screw - M3x5	
106	0574 0050E	Hexagon Headless Set Screw - M4x5	
107	1105 0008	Nylon Clip - 2N	
108	0314 0080W	Philips Pan Head Screw - M4x8	
110	0314 0120W	Philips Pan Head Screw - M4x12	

3. EXTERIOR 1 (A463)

April 30, '89

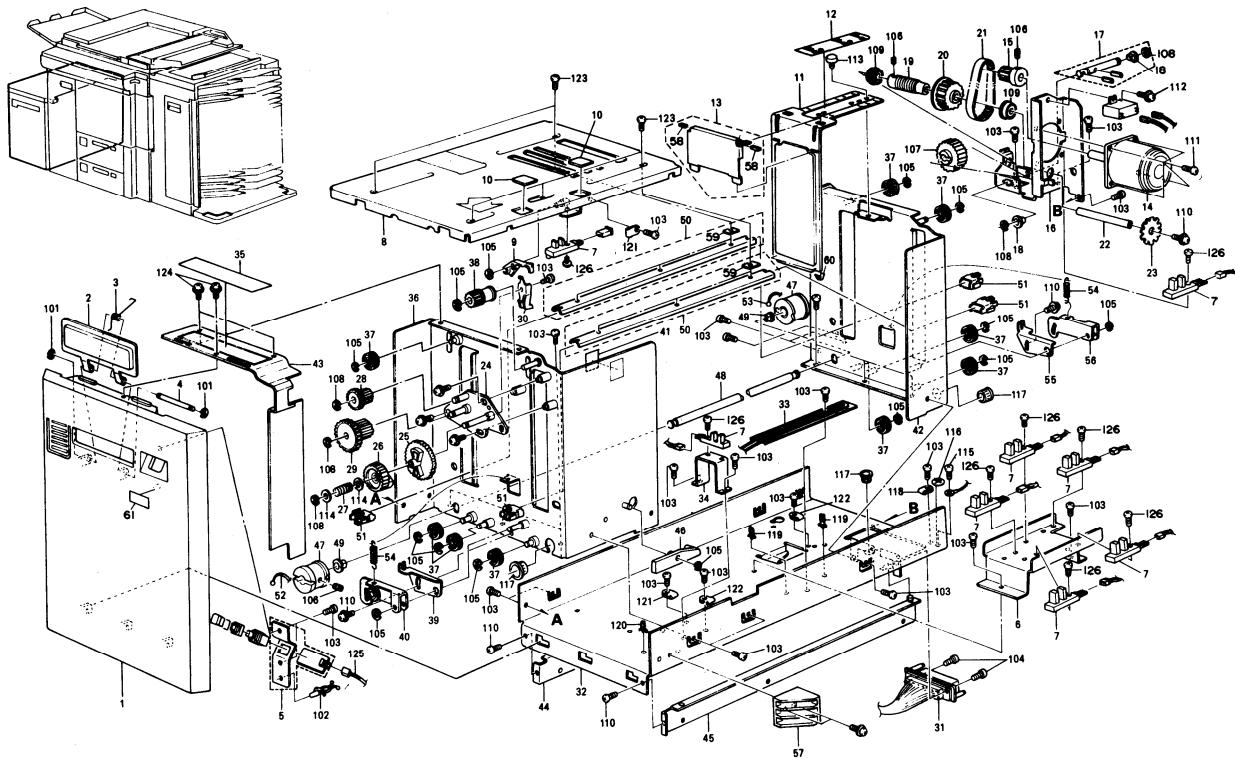

4. EXTERIOR 2 (A463)

April 30, '89

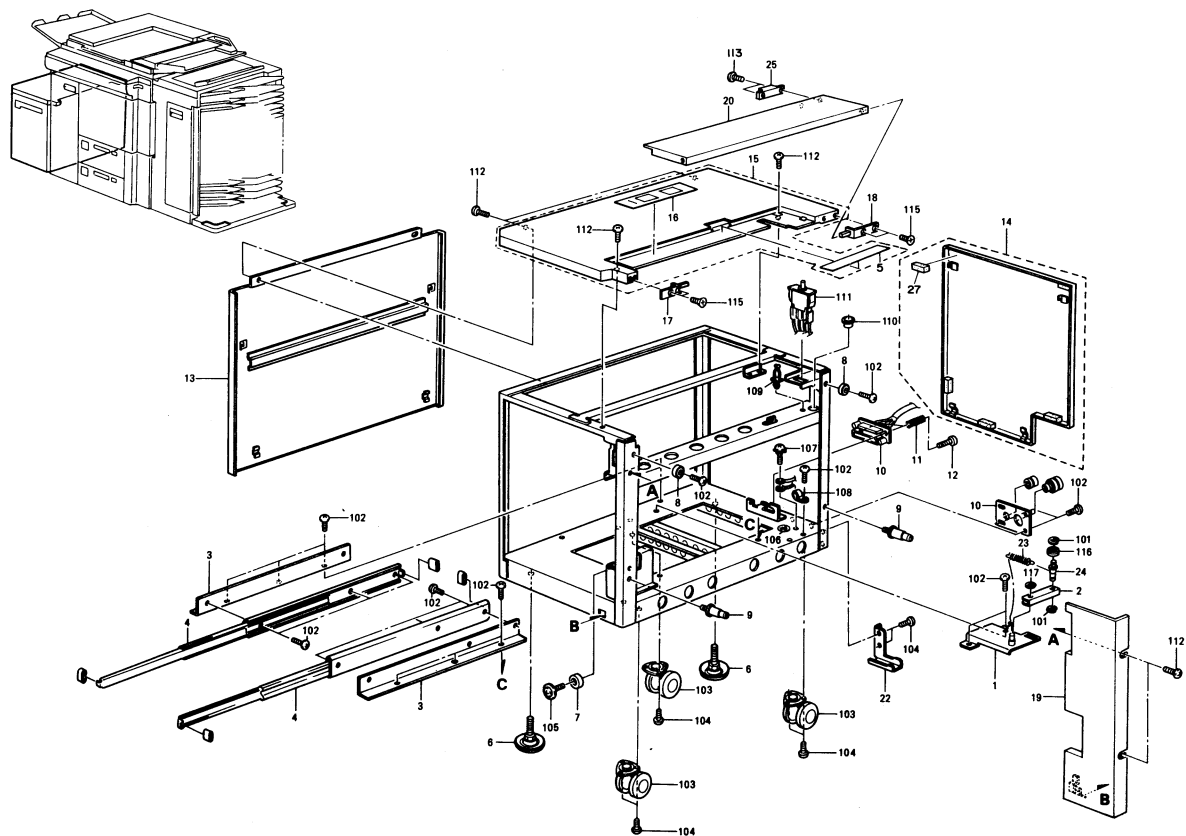

4. EXTERIOR 2 (A463)

April 30, '89

Index No.	Part No.	Description	Q'ty Per Assembly
1	5938 2751	Detent Bracket	1
2	5446 2566	Detent Arm	1
3	5938 2757	Slide Bracket	2
4	5938 2763	Slide Guide	2
5	A463 2961	Magnet Sheet - 1.5x38x100mm	1
6	5424 1064	Screw Stand	2
7	5446 2560	Cushion - Paper Tray	1
8	5938 2765	Rubber Pad	2
9	5938 2764	Docking Pin	2
10	5938 5016	Option Tray Harness	1
11	5424 2625	Spring - Connector	2
12	5446 5832	Connector Guide Pin	1
13	A463 2716	Left Cover - Large Capacity Tray	1
14	A463 2721	Rear Cover - Large Capacity Tray	1
15	A463 2975	Top Cover	1
16	A463 7012	Decal - Misfeed Removal 6-1	1
17	5938 2911	Front Support Plate	1
18	5938 2915	Rear Support Plate	1
19	A463 2738	Right Cover - Large Capacity Tray	1
20	A463 2970	Access Cover	1
22	5938 2730	Setting Bracket	1
23	5446 2569	Spring - Detent	1
24	5446 2567	Detent Arm Shaft	1
25	AG07 0004	Magnet Catch Ass'y	1
27	5938 2718	Stopper - Rear Cover	6



Index No.	Part No.	Description	Q'ty Per Assembly
101	0720 0040E	Retaining Ring - M4	
102	0314 0060W	Philips Pan Head Screw - M4x6	
103	0805 5003	Caster	
104	0315 0080W	Philips Pan Head Screw - M5x8	
105	0951 4010W	Philips Screw With Flat Washer - M4x10	
106	1005 0335	Earth Mark	
107	0801 1185	Philips Truss Head Screw - M4x8	
108	1105 0012	Nylon Clip - 10N	
109	1105 0090	Cable Clip - 7mm	
110	1106 0200	Bushing - 19.44mm	
111	1204 1231	Switch - F84A-A130	
112	0344 0080F	Philips Truss Head Screw - M4x8	
113	0313 0060W	Philips Pan Head Screw - M3x6	
115	0324 0060G	Philips Sunken Head Screw - M4x6	
116	0805 3270	Ball Bearing - 8x16x5mm	
117	0720 0060E	Retaining Ring - M6	

5. HARNESS LAYOUT (A463)

April 30, '89

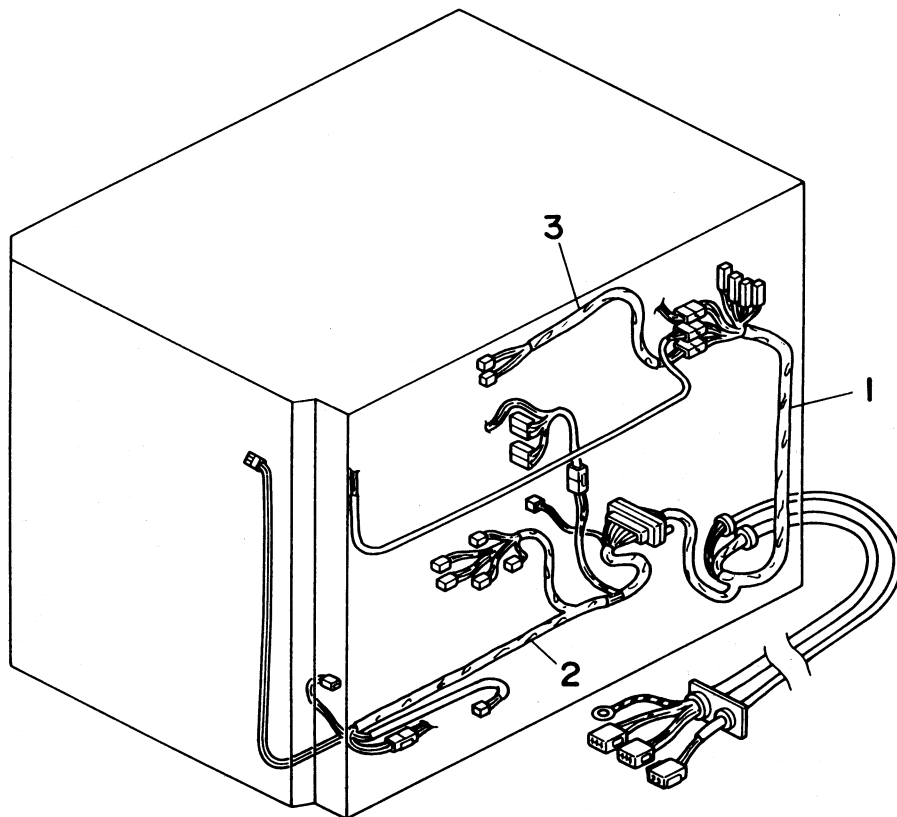

5. HARNESS LAYOUT (A463)

April 30, '89

Index No.	Part No.	Description	Q'ty Per Assembly
1	5938 5016	Option Tray Harness	1
2	5938 5008	Drawer Harness	1
3	5938 5009	Join Harness	1

Index No.	Part No.	Description	Q'ty Per Assembly
-----------	----------	-------------	-------------------

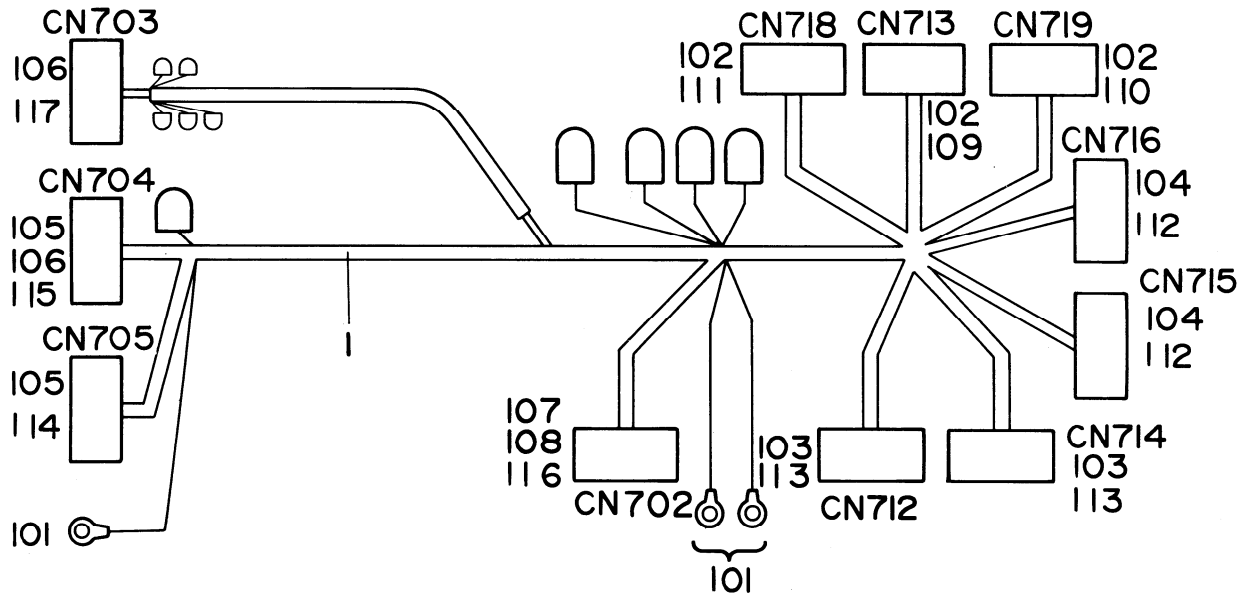

6. OPTION TRAY HARNESSSES (A463)

April 30, '89

Index No.	Part No.	Description	Q'ty Per Assembly
1	5938 5016	Option Tray Harness	1

Index No.	Part No.	Description	Q'ty Per Assembly
101	1100 0082	Solid Strand	
102	1100 1159	Socket - Mate-N-Lock	
103	1100 1169	Fastening Receptacle	
104	1100 1172	Fastening Receptacle	
105	1100 1238	Pin - Mate-N-Lock	
106	1100 1239	Pin - Mate-N-Lock	
107	1100 1266	Socket - Mate-N-Lock	
108	1100 1267	Socket - Mate-N-Lock	
109	1102 1307	Connector - 4P	
110	1102 1308	Connector - 6P	
111	1102 1326	Connector - 3P	
112	1102 1404	Receptacle Housing	
113	1102 1408	Connector - 1P	
114	1102 1512	Connector - 12P	
115	1102 1513	Connector - 15P	
116	1102 1725	Connector - 24P	
117	1102 1510	Connector - 6P	

7. DRAWER AND JOIN HARNESSES (A463)

April 30, '89

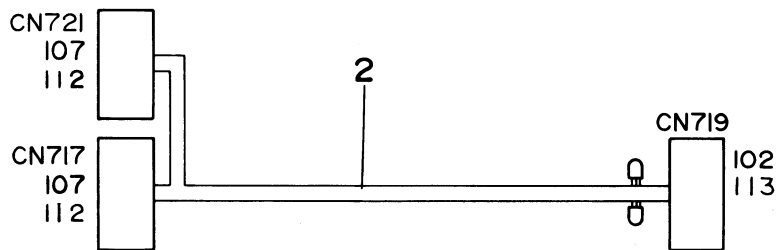
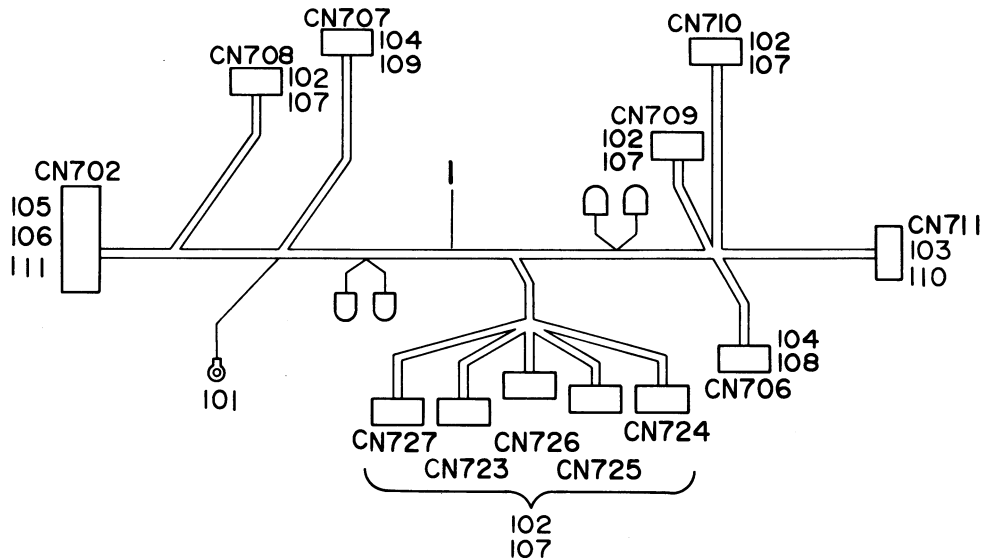

7. DRAWER AND JOIN HARNESSSES (A463)







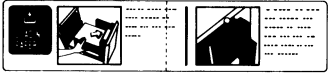
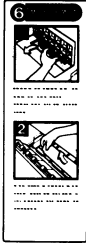
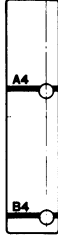
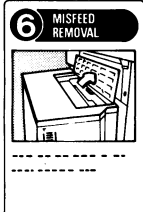
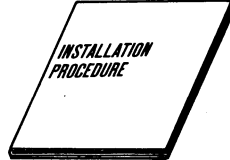





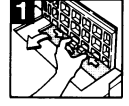
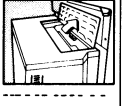
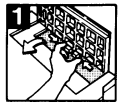

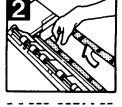





April 30, '89

Index No.	Part No.	Description	Q'ty Per Assembly
1	5938 5008	Drawer Harness	1
2	5938 5009	Join Harness	1

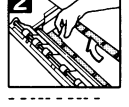
Index No.	Part No.	Description	Q'ty Per Assembly
101	1100 0082	Solid Strand	
102	1100 1089	Socket - Mate-N-Lock	
103	1100 1204	Socket - Mate-N-Lock	
104	1100 1241	Socket - Mate-N-Lock	
105	1100 1266	Socket - Mate-N-Lock	
106	1100 1267	Socket - Mate-N-Lock	
107	1102 1089	Connector - 3P	
108	1102 1515	Connector - 2P	
109	1102 1516	Connector - 3P	
110	1102 1632	Connector - 4P	
111	1102 1724	Connector - 24P	
112	1100 1159	Socket - Mate-N-Lock	
113	1102 1492	Connector - 6P	

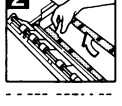
<p>1</p> 	<p>2</p> 	<p>3</p> 
<p>4</p>  <p>6 MISFEED REMOVAL</p>	<p>5</p>  <p><i>INSTALLATION PROCEDURE</i></p>	<p>6</p> <div style="border: 1px solid black; padding: 10px; text-align: center;"> <p>Pull out paper tray when the button lights steadily.</p> </div>

7

  	<p>Francis/フランス語 ▼</p>	
<p>6 PAPIERSTAU BESEITIGUNG</p> 	<p>6 PAPIERSTAU BESEITIGUNG</p> 	<p>6 EXTRACTION BOURRAGE</p> 
	<p>6 EXTRACTION BOURRAGE</p> 	
<p>Deutsch/ドイツ語 ▲</p>	  	
  	<p>Italiano/イタリア語 ▼</p>	
<p>6 DESPEJE DE ALIMENTACION INCORRECTA</p> 	<p>6 DESPEJE DE ALIMENTACION INCORRECTA</p> 	<p>6 RIMOZIONE INCEPPAMENTO</p> 
	<p>6 RIMOZIONE INCEPPAMENTO</p> 	
<p>Espanol/スペイン語 ▲</p>	  	

PARTS INDEX

Parts No.	Description	Page and Index No.
A463 2560	Paper Conveyer Unit	5-31
A463 2716	Left Cover - Large Capacity Tray	11-13
A463 2721	Rear Cover - Large Capacity Tray	11-14
A463 2723	Front Cover - Large Capacity Tray	9-1
A463 2732	Shutter	9-2
A463 2738	Right Cover - Large Capacity Tray	11-19
A463 2901	Open Section Knob	7-31
A463 2961	Magnet Sheet - 1.5x38x100mm	11-5
A463 2970	Access Cover	11-20
A463 2975	Top Cover	11-15
A463 7003	Drawer Upper Cover	9-43
A463 7004	Decal - Loading Paper	19-1
A463 7004	Decal - Loading Paper	9-35
A463 7012	Decal - Misfeed Removal 6-1	11-16
A463 7012	Decal - Misfeed Removal 6-1	19-2
A463 7027	Drawer Feed Plate - LT	9-8
A463 7028	Drawer Feed Plate - A4	9-8
A463 7031	Decal - Paper Size - LT	19-3
A463 7031	Decal - Paper Size - LT	9-12
A463 7032	Decal - Paper Size - A4	19-3
A463 7032	Decal - Paper Size - A4	9-12
A463 7035	Decal - Misfeed Removal 6-2	19-4
A463 7041	Decal - Multi	19-7
A463 8610	Installation Procedure - English	19-5
A463 8615	Installation Procedure - Multi	19-5

Parts No.	Description	Page and Index No.
AB01 3032	Gear - 45T	9-107
AG07 0004	Magnet Catch Ass'y	11-25
A029 4677	Release Lever	5-14
A029 4982	Decal - Release Plate	5-30
5053 0419	Bushing - 10mm	9-49
5053 0447	Bushing - 6x10x6mm	7-11
5201 1796	Stepped Screw - M4	5-15
5219 2898	Holder - Paper Feed Roller	7-24
5219 2931	Upper Separation Roller	7-22
5219 2940	Bottom Separation Roller	7-19
5219 5500	Tray Button Switch	9-5
5219 5600	Photo Coupler	7-41
5219 5600	Photo Coupler	9-7
5219 6069	Release Spring - Duplex Unit	5-16
5304 1639	Bushing - 8mm	7-3
5304 1639	Bushing - 8mm	9-18
5403 1030	Tension Spring	9-54
5403 6246	Stepped Screw - Cleaning	5-17
5415 2642	Lock Arm	9-46
5424 1064	Screw Stand	11-6
5424 2625	Spring - Connector	11-11
5424 2632	Pad - Tray	9-10
5429 7069	Pick-up Roller	7-27
5446 2560	Cushion - Paper Tray	11-7
5446 2566	Detent Arm	11-2
5446 2567	Detent Arm Shaft	11-24
5446 2569	Spring - Detent	11-23
5446 2620	Idler Pulley - 20	9-37
5446 2625	Gear - 18T	9-38
5446 2630	Front Wire Tightener	9-56
5446 2638	Decal - Paper Lower Limit	9-41
5446 2645	Rear Wire Tightener	9-40
5446 2671	Drive Pulley - Paper Tray	9-47
5446 2686	Paper End Feeler	9-9
5446 2712	Spring - Reverse Gear	9-27

Parts No.	Description	Page and Index No.
5446 2713	Gear - 16T/30T	9-28
5446 2714	Gear - 16T/44T	9-29
5446 2715	Paper Tray Stopper	9-57
5446 2718	Balancer - Bracket	9-30
5446 2723	Shutter Shaft	9-4
5446 2724	Spring - Shutter	9-3
5446 2728	Gear - 36T	9-26
5446 2729	Gear - 50T	9-25
5446 2799	Spring - Transport Roller	7-33
5446 2862	Gear - 36T	7-4
5446 2874	Positioning Arm	7-42
5446 2891	Peper Feed Gear - 22T	7-23
5446 2895	Gear - 20T	7-25
5446 2901	Collar - 8mm	7-26
5446 2924	Mylar - Separation Guide	7-46
5446 2926	Shaft - Lower Separation Roller	7-21
5446 3158	Gear - 16T	5-23
5446 5445	Magnetic Clutch - 5KGF.CM 20T	7-29
5446 5463	Dehumidity Heater	9-33
5446 5832	Connector Guide Pin	11-12
5446 8870	Decal - English	19-6
5446 8870	Decal - English	9-61
5866 1677	Belt Roller Gear - 17T	7-37
5875 2067	Bushing - 6x10x6mm	5-21
5938 2553	Front Side - Lateral Transport	5-13
5938 2560	Rear Side Plate - Lateral Transport	5-22
5938 2563	Upper Transport Roller	5-19
5938 2565	Guide Plate - Lateral Transport	5-18
5938 2569	Scraper - Paper Dust Cleaner	5-20
5938 2576	Coupled Gear - 16T/18T	5-24
5938 2580	Lower Guide Plate	5-25
5938 2595	Lower Transport Roller	5-26
5938 2597	Pressure Bushing - 8mm	5-27
5938 2597	Pressure Bushing - 8mm	7-35
5938 2598	Spring - Lower Transport Roller	5-28

Parts No.	Description	Page and Index No.
5938 2599	Pressure Plate - Transport Roller	5-29
5938 2600	Paper Conveyer Drive Unit	5-32
5938 2601	Bracket - Lateral Transport Drive	5-9
5938 2605	Right Shaft - Lateral Transport Drive	5-7
5938 2607	Gear - 25T	5-8
5938 2609	Pulley - 14T	5-11
5938 2611	Left Shaft - Lateral Transport Drive	5-5
5938 2613	Gear - 25T	5-6
5938 2615	Timing Belt - 130XL	5-10
5938 2618	Stud - Lateral Transport Drive	5-1
5938 2620	Gear - 31T	5-4
5938 2622	Gear - 36T	5-2
5938 2625	Paper Guide Plate	5-3
5938 2718	Stopper - Rear Cover	11-27
5938 2730	Setting Bracket	11-22
5938 2751	Detent Bracket	11-1
5938 2757	Slide Bracket	11-3
5938 2758	Right Slide Bracket	9-45
5938 2759	Left Slide Bracket	9-44
5938 2763	Slide Guide	11-4
5938 2764	Docking Pin	11-9
5938 2765	Rubber Pad	11-8
5938 2773	Front Plate - Option Tray	9-36
5938 2774	Rear Side Plate - Option Tray	9-42
5938 2780	Front Stopper	9-39
5938 2781	Rear Stopper	9-55
5938 2782	Drawer - Option Tray	9-32
5938 2783	Tray Support Bracket	9-50
5938 2784	Pad - Tray Support Bracket	9-59
5938 2785	Support Plate Stopper	9-51
5938 2786	Drive Shaft	9-48
5938 2788	Front Wire - Option Tray	9-52
5938 2789	Rear Wire - Option Tray	9-53
5938 2801	Drive Bracket - Paper Tray	9-16
5938 2803	Drive Gear Shaft	9-17

Parts No.	Description	Page and Index No.
5938 2806	Worm Gear Shaft	9-22
5938 2807	Worm Gear	9-19
5938 2808	Pulley - 24T	9-20
5938 2809	Paper Volume Disk	9-23
5938 2810	Pulley - 12T	9-15
5938 2812	Timing Belt - 90XL	9-21
5938 2816	Reverse Gear Plate	9-24
5938 2820	Bracket - Paper Size Sensor	9-6
5938 2822	Bracket - Lower Limit Sensor	9-34
5938 2826	Side Fence Bracket	9-11
5938 2829	Plate Spring - Side Fence	9-13
5938 2830	Guard Rubber - Plate Spring	9-58
5938 2831	Sheet - Side Fence	9-60
5938 2843	Paper Feed Frame	7-1
5938 2856	Transport Drive Roller	7-2
5938 2857	Pressure Shaft - Separation Roller	7-10
5938 2859	Reverse Gear Shaft	7-13
5938 2862	Lower Guide Plate	7-17
5938 2866	Shaft - Upper Separation Roller	7-39
5938 2867	Actuator - Upper Volume Sensor	7-28
5938 2868	Gear - 18T	7-16
5938 2869	Separation Roller Stopper	7-12
5938 2870	Pressure Lever - Separation Roller	7-14
5938 2871	Upper Guide - Separation Roller	7-18
5938 2872	Bracket - Upper Limit Sensor	7-40
5938 2873	Upper Transport Guide	7-20
5938 2876	Gear Shaft Holder	7-45
5938 2877	Gear Shaft - 30T	7-43
5938 2878	Gear - 30T	7-44
5938 2880	Gear - 20T	7-8
5938 2882	Coupled Gear - 16T/24T	7-6
5938 2883	Gear - 24T	7-5
5938 2884	Drive Gear Bracket	7-7
5938 2885	Spring - Gear Shaft Holder	7-9
5938 2888	Open Section Bracket	7-51

Parts No.	Description	Page and Index No.
5938 2889	Front Lock Lever	7-52
5938 2890	Rear Lock Lever	7-53
5938 2892	Spring - Lock Lever	7-32
5938 2893	Pressure Plate	7-34
5938 2894	Transport Driven Roller	7-36
5938 2895	Guide Plate - Open Section	7-38
5938 2899	Separation Roller Cover	7-50
5938 2902	Bracket Paper Feed Sensor	7-48
5938 2905	Spring - Separation Poller	7-15
5938 2907	Spring - Paper Feed Pressure	7-30
5938 2911	Front Support Plate	11-17
5938 2915	Rear Support Plate	11-18
5938 5005	Option Tray Motor - AC30W	9-14
5938 5008	Drawer Harness	13-2
5938 5008	Drawer Harness	17-1
5938 5008	Drawer Harness	9-31
5938 5009	Join Harness	13-3
5938 5009	Join Harness	17-2
5938 5009	Join Harness	7-47
5938 5011	Papeer Feed Sensor	7-49
5938 5016	Option Tray Harness	11-10
5938 5016	Option Tray Harness	13-1
5938 5016	Option Tray Harness	15-1

Parts No.	Description	Page and Index No.
0313 0050W	Philips Pan Head Screw - M3x5	7-105
0313 0050W	Philips Pan Head Screw - M3x5	9-123
0313 0060W	Philips Pan Head Screw - M3x6	11-113
0314 0060W	Philips Pan Head Screw - M4x6	11-102
0314 0060W	Philips Pan Head Screw - M4x6	5-106
0314 0060W	Philips Pan Head Screw - M4x6	7-104
0314 0060W	Philips Pan Head Screw - M4x6	9-103
0314 0080W	Philips Pan Head Screw - M4x8	7-108
0314 0100W	Philips Pan Head Screw - M4x10	9-104
0314 0120W	Philips Pan Head Screw - M4x12	7-110
0314 0120W	Philips Pan Head Screw - M4x12	9-126
0315 0080W	Philips Pan Head Screw - M5x8	11-104
0315 0140W	Philips Pan Head Screw - M5x14	9-111
0324 0060G	Philips Sunken Head Screw - M4x6	11-115
0344 0080F	Philips Truss Head Screw - M4x8	11-112
0574 0050E	Hexagon Headless Set Screw - M4x5	7-106
0575 0050E	Hexagon Headless Set Screw - M5x5	5-105
0575 0050E	Hexagon Headless Set Screw - M5x5	9-106
0720 0030E	Retaining Ring - M3	9-101
0720 0040E	Retaining Ring - M4	11-101
0720 0040E	Retaining Ring - M4	5-107
0720 0040E	Retaining Ring - M4	7-103
0720 0040E	Retaining Ring - M4	9-105
0720 0060E	Retaining Ring - M6	11-117
0720 0060E	Retaining Ring - M6	5-101
0720 0060E	Retaining Ring - M6	5-103
0720 0060E	Retaining Ring - M6	7-101
0720 0060E	Retaining Ring - M6	9-108
0742 3008	Ball Bearing - 8x22mm	9-109
0742 3808	Ball Bearing - 8x16mm	5-102
0742 3808	Ball Bearing - 8x16mm	7-102
0742 3906	Ball Bearing - M8	5-108
0801 1185	Philips Truss Head Screw - M4x8	11-107
0801 1185	Philips Truss Head Screw - M4x8	9-115
0803 0052	Knob Screw	9-113

Parts No.	Description	Page and Index No.
0805 3270	Ball Bearing - 8x16x5mm	11-116
0805 5003	Caster	11-103
0807 5011	Washer - 8.1x14x0.5mm	9-114
0951 4006W	Philips Screw With Flat Washer - M4x6	5-109
0951 4006W	Philips Screw With Flat Washer - M4x6	9-110
0951 4008W	Philips Screw With Flat Washer - M4x8	9-124
0951 4010W	Philips Screw With Flat Washer - M4x10	11-105
0951 4010W	Philips Screw With Flat Washer - M4x10	9-112
1005 0335	Earth Mark	11-106
1005 0335	Earth Mark	9-116
1100 0082	Solid Strand	15-101
1100 0082	Solid Strand	17-101
1100 1089	Socket - Mate-N-Lock	17-102
1100 1159	Socket - Mate-N-Lock	15-102
1100 1159	Socket - Mate-N-Lock	17-112
1100 1169	Fastening Receptacle	15-103
1100 1172	Fastening Receptacle	15-104
1100 1204	Socket - Mate-N-Lock	17-103
1100 1238	Pin - Mate-N-Lock	15-105
1100 1239	Pin - Mate-N-Lock	15-106
1100 1241	Socket - Mate-N-Lock	17-104
1100 1266	Socket - Mate-N-Lock	15-107
1100 1266	Socket - Mate-N-Lock	17-105
1100 1267	Socket - Mate-N-Lock	15-108
1100 1267	Socket - Mate-N-Lock	17-106
1102 0904	Connector - 4P	9-125
1102 1089	Connector - 3P	17-107
1102 1307	Connector - 4P	15-109
1102 1308	Connector - 6P	15-110
1102 1326	Connector - 3P	15-111
1102 1404	Receptacle Housing	15-112
1102 1408	Connector - 1P	15-113
1102 1492	Connector - 6P	17-113
1102 1510	Connector - 6P	15-117
1102 1512	Connector - 12P	15-114

Parts No.	Description	Page and Index No.
1102 1513	Connector - 15P	15-115
1102 1515	Connector - 2P	17-108
1102 1516	Connector - 3P	17-109
1102 1632	Connector - 4P	17-110
1102 1724	Connector - 24P	17-111
1102 1725	Connector - 24P	15-116
1105 0005	Nylon Clip - 3N	9-121
1105 0008	Nylon Clip - 2N	7-107
1105 0009	Nylon Clip - 5N	9-122
1105 0010	Nylon Clip - 6N	9-118
1105 0012	Nylon Clip - 10N	11-108
1105 0089	Cable Clip - 11.5mm	9-119
1105 0090	Cable Clip - 7mm	11-109
1105 0090	Cable Clip - 7mm	9-102
1105 0090	Cable Clip - 7mm	9-120
1106 0200	Bushing - 19.44mm	11-110
1106 0200	Bushing - 19.44mm	9-117
1204 1231	Switch - F84A-A130	11-111

Parts No.	Description	Page and Index No.